

Gebrauchsanweisung  
 51 7993  
 (D,GB,F,NL,I,E,GR)

Montageanleitung  
 51 7991  
 (D,GB,F,NL,I,E,GR)

Tips und Rezepte  
 51 8100  
 (D)

Zubehör:

Grillpfanne u. Bratrost  
 Z1230X0

Backblech, Alu  
 Z1330X0

Backblech Email  
 Z1340X0

Bratrost gekröpft  
 Z1430X0

Bratrost engmaschig  
 Z1440X0

1)02 5876

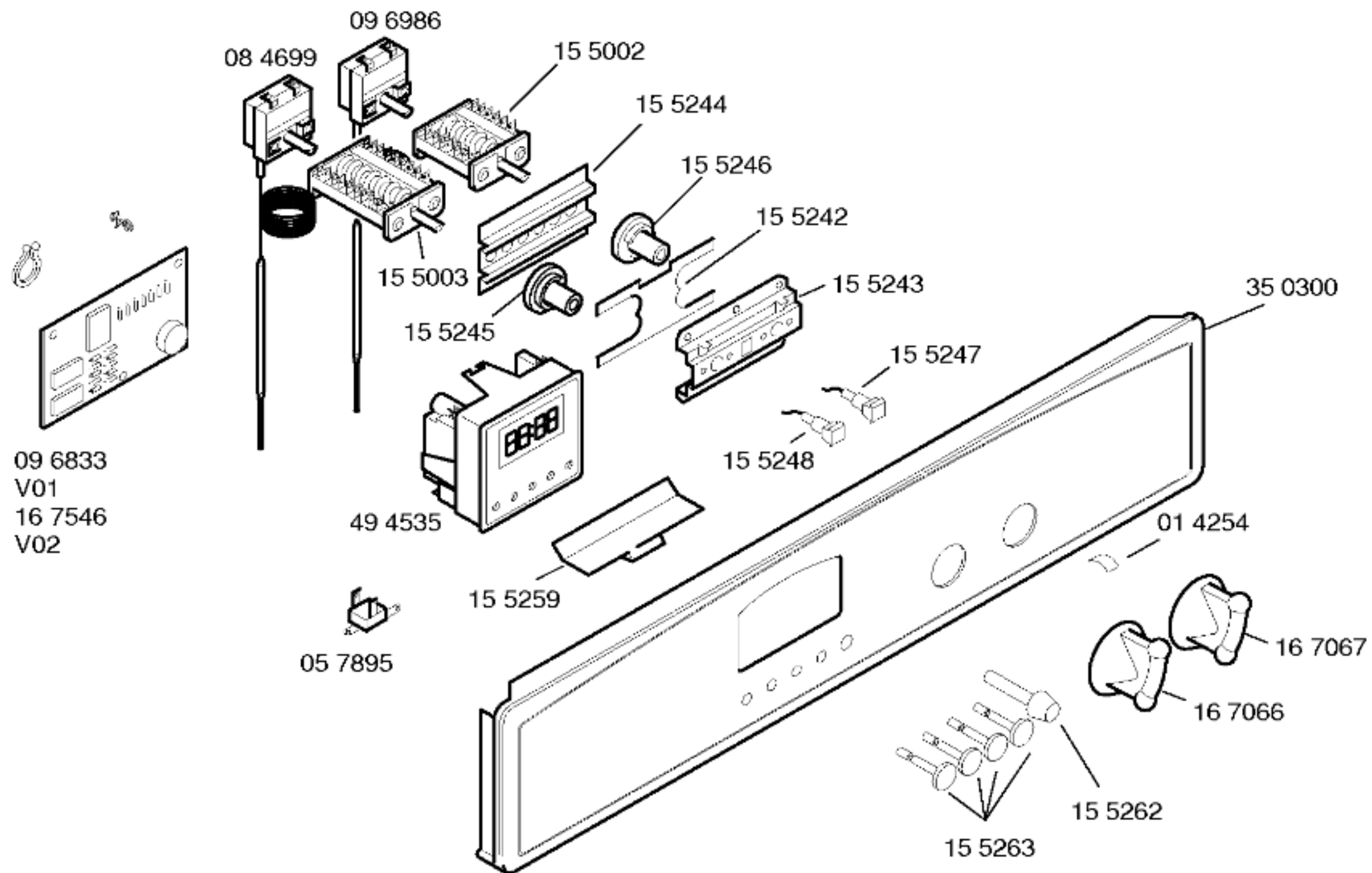

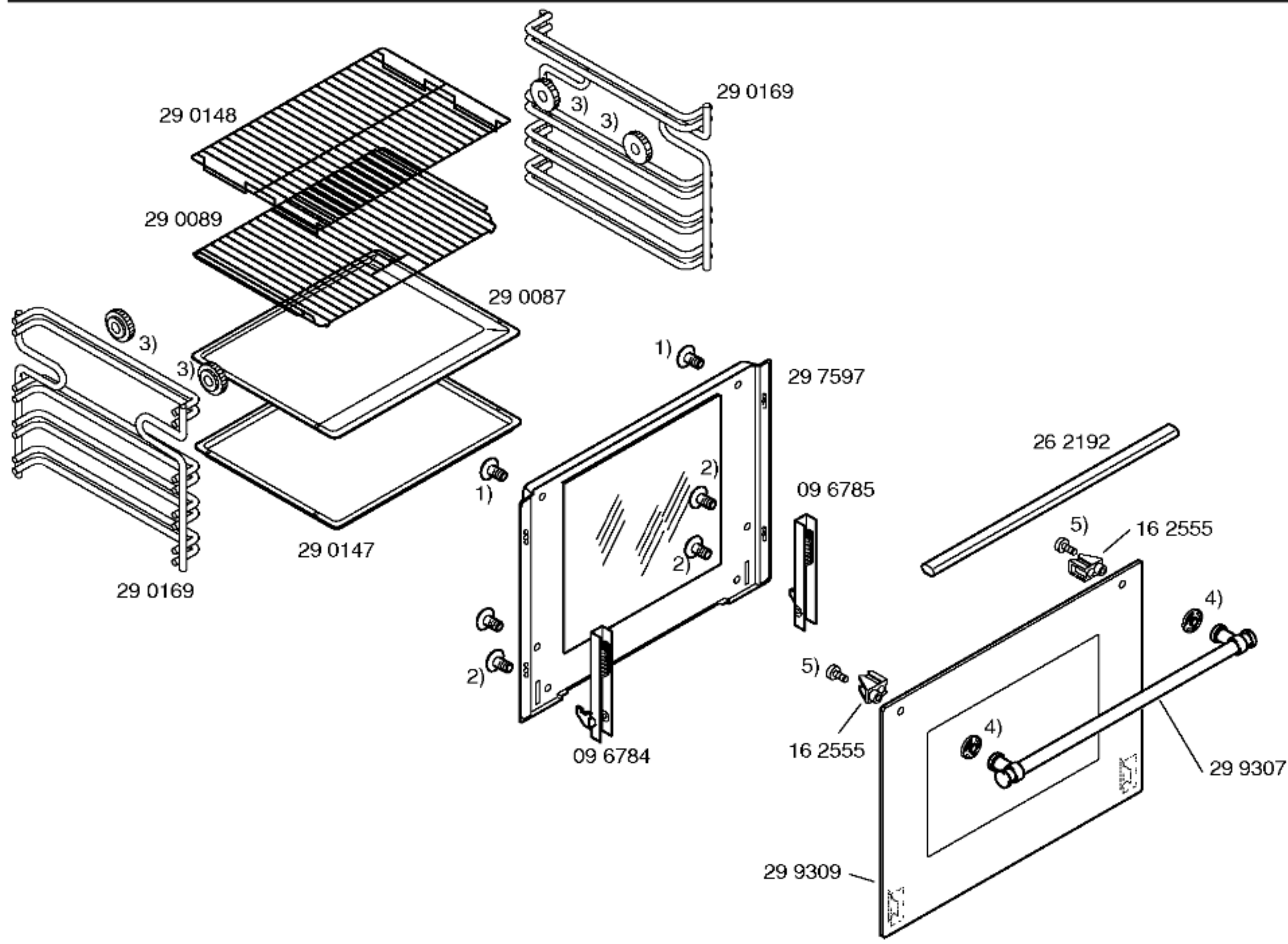

- 1) 15 4762
- 2) 15 4763
- 3) 02 6593
- 4) 16 3041
- 5) 16 8581

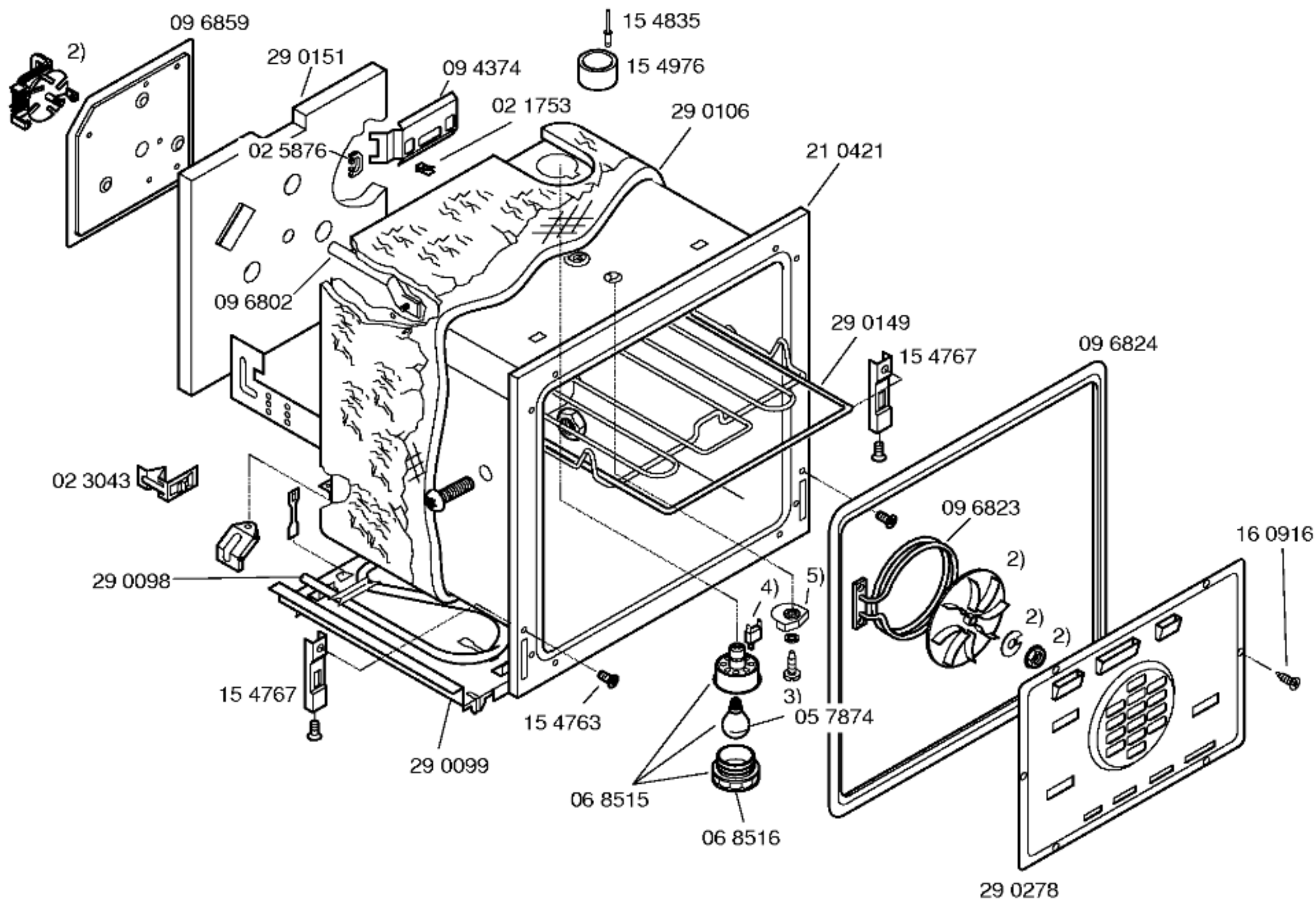

- 1) 05 7874
- 2) 09 6825  
kompl.
- 3) 06 9709
- 4) 15 4836
- 5) 15 5033